

PANL

Fräsch was founded on the belief that creating healthy and beautiful office environments leads to a happier and highly motivated workforce.



PANL

PET Felt Screens

The PANL walls create a visual and acoustical division for your space. The pattern allows light to go through while providing an acoustical value and privacy. These free-flowing screens are a fantastic way to divide a space, add acoustical properties, and allow for endless possibilities to personalize with perforation styles.

Application	Room Divider			
	L	W	H	WEIGHT
PANL	48"	.35"	96"	1.02 lbs.

Custom sizing available
 Custom perforated and print options available

Hardware

Default: Spike Bracket, Aircraft Cable/Threaded Rod, Coupler Nut, Griplock, Hanger Bolt
 Unistrut*: Unistrut, Cone Nut Assembly, Threaded Rod/Aircraft Cable, Coupler Nut, Griplock

* Available Upon Request

Material Content 9 mm 100% PET (55% recycled content)

Fire Rating Class A per ASTM E-84, based on 9mm white

Acoustics

Frequency (Hz)	250	500	1K	2K	NRC
NRC	0.35	0.54	0.85	1.22	0.75
Sabins per m ²	1.40	2.17	3.39	4.89	

Test was conducted while product was in its actual installation setting

All NRC testings assumes one face/one object and does not account for the product thickness

Environment

Low VOC;
 Post-Consumer Recycled Content
 100% Recyclable

Installation

PANL comes with two perfectly placed and pre-installed T-Nuts for easy connectivity and quick install. Threaded Rod, Coupling Nut and Cable Grippers are included. The ceiling fastener is provided by an installer based of a ceiling type.

Country of Origin

USA

Warranty

2 Years

PANL

DIMENSIONS & HARDWARE DETAIL

PANL Dimensions

Standard

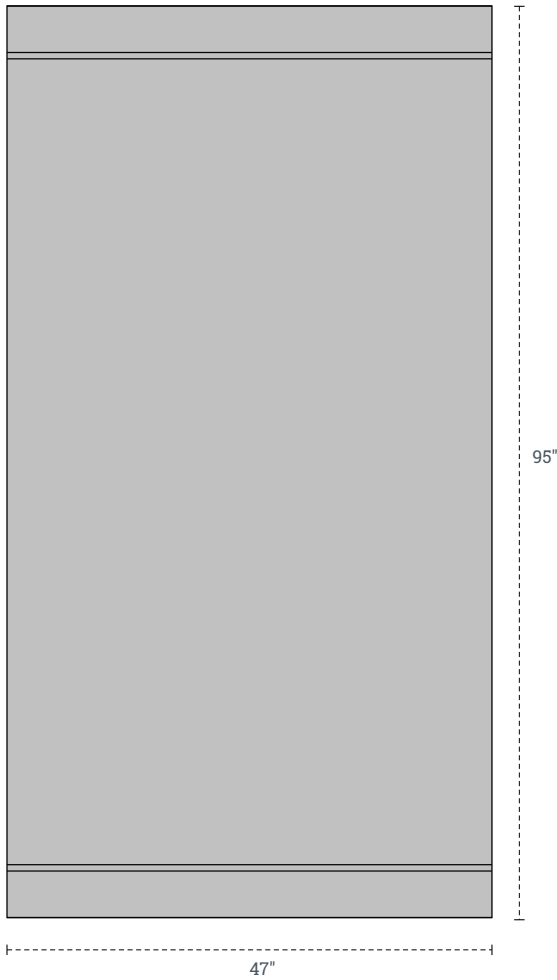

Custom

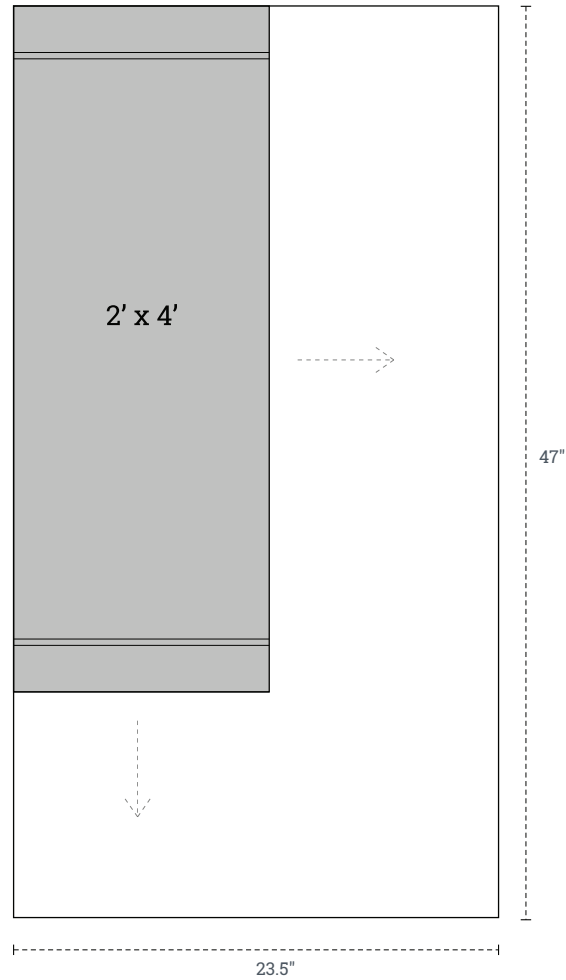

** Custom Widths from 2' to 4'
** Custom Heights from 2' to 8'

PANL

DIMENSIONS & HARDWARE DETAIL

Aircraft Cable

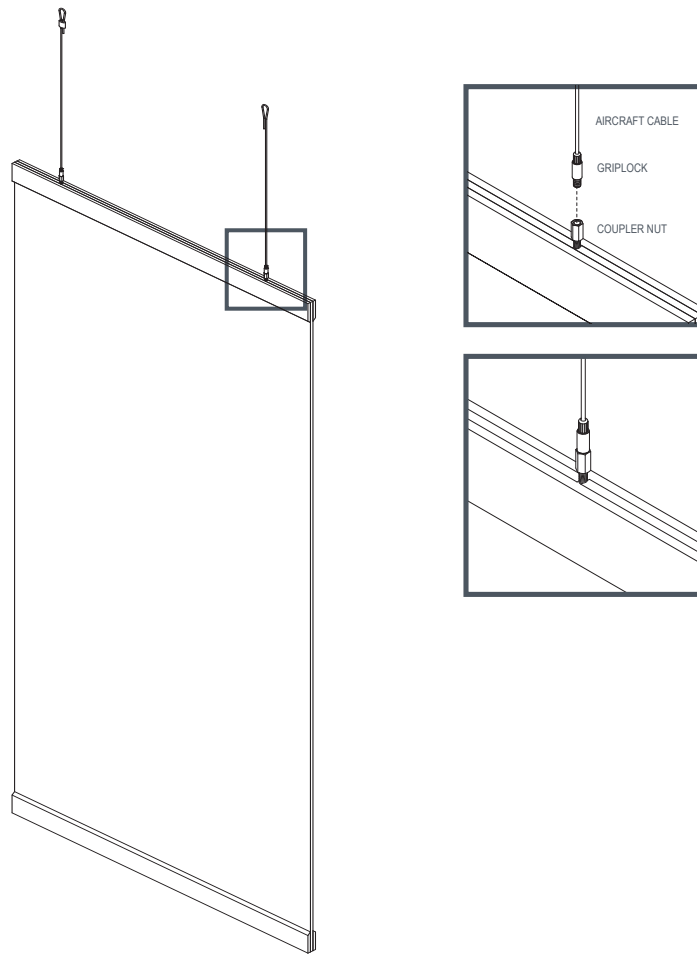

PANL

DIMENSIONS & HARDWARE DETAIL

Spike Bracket

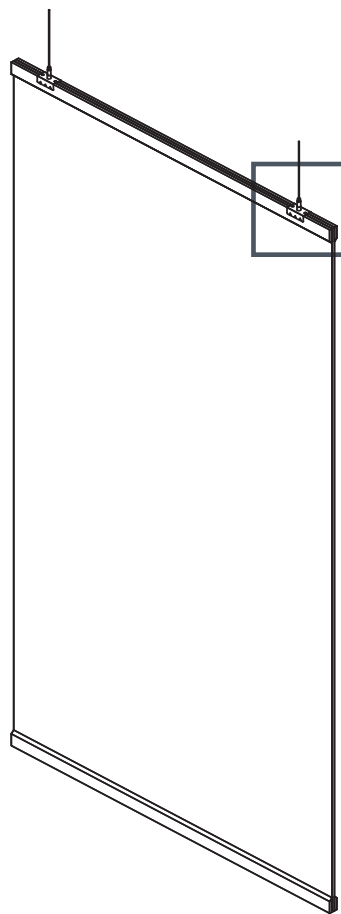

27mm Spike Bracket

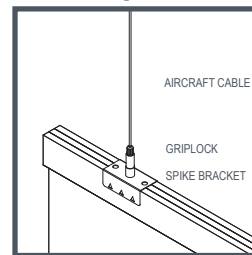

9mm Spike Bracket

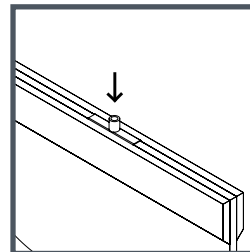
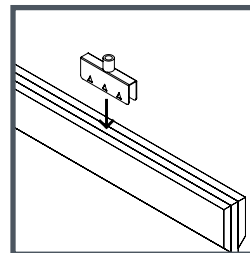

PANL

DIMENSIONS & HARDWARE DETAIL

Magnetic Connectors

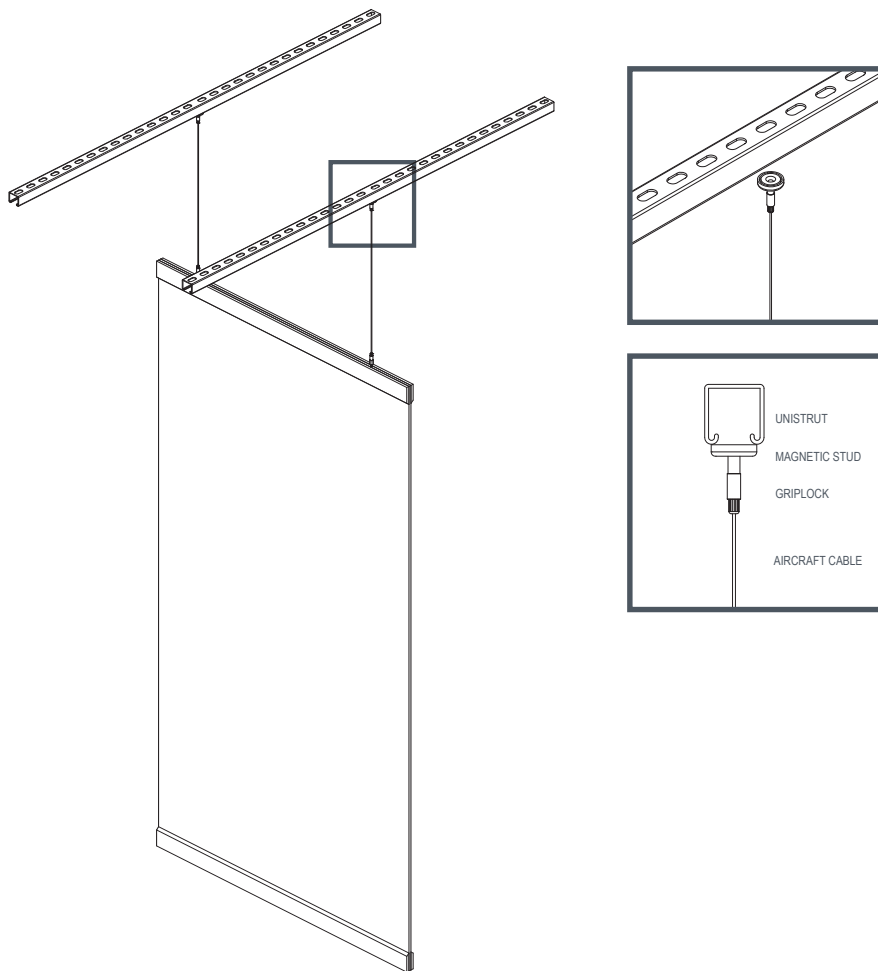

PANL

DIMENSIONS & HARDWARE DETAIL

Conduit Clip

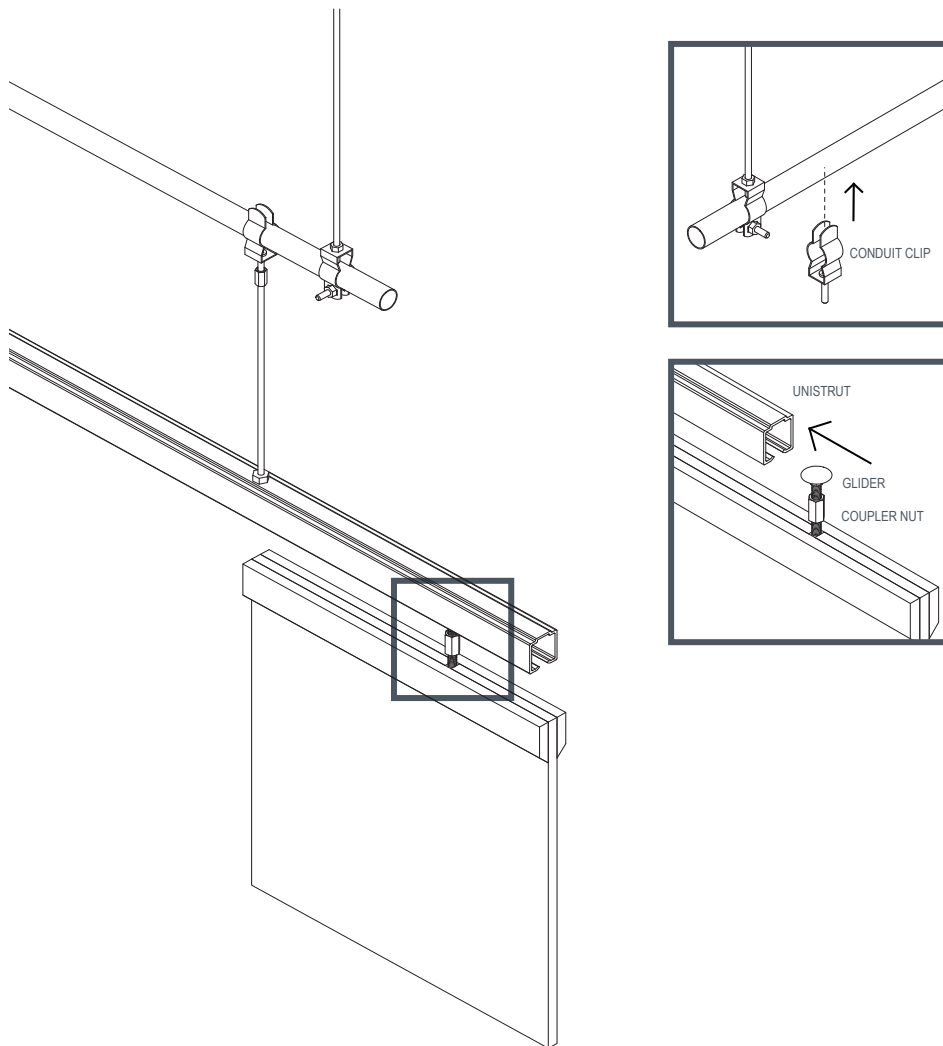

PANL

DIMENSIONS & HARDWARE DETAIL

Suspended

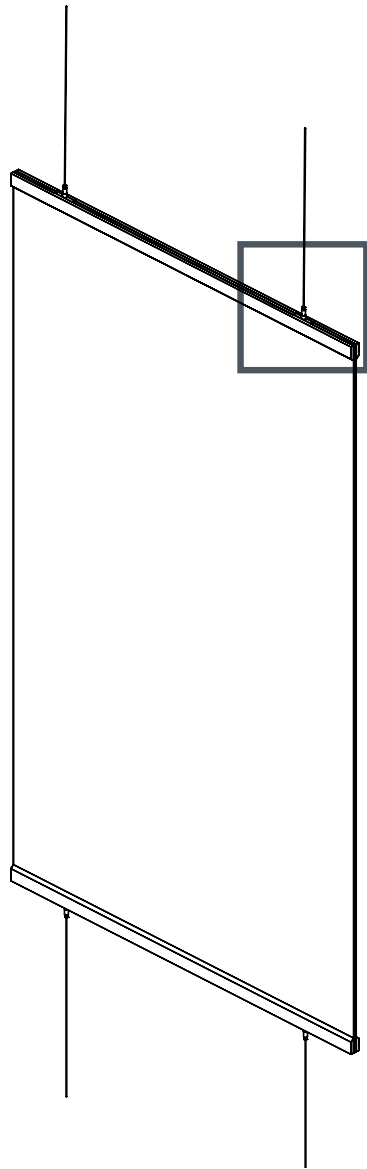

Aircraft Cable

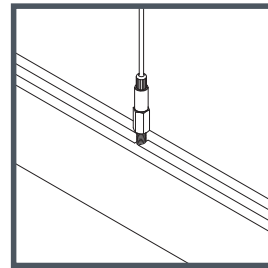
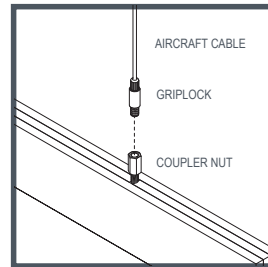

9mm Spike Bracket

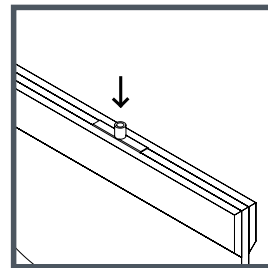
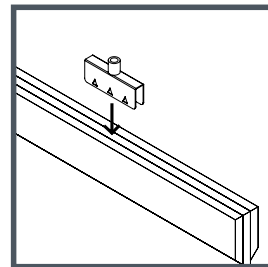

PANL

DIMENSIONS & HARDWARE DETAIL

Hanging Aluminum Channel

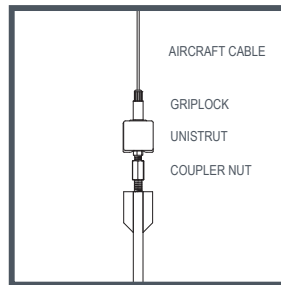
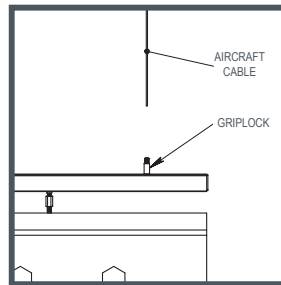
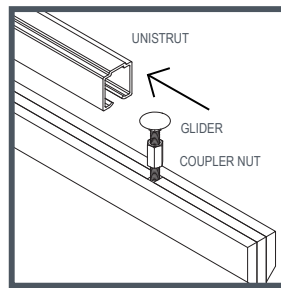
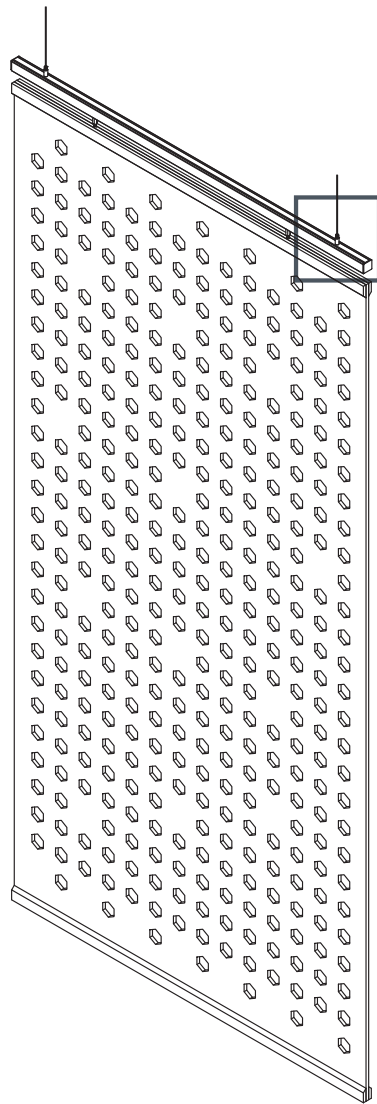

PANL

DIMENSIONS & HARDWARE DETAIL

T-Grid

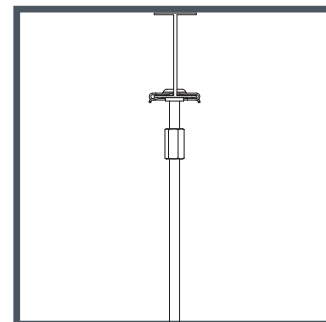
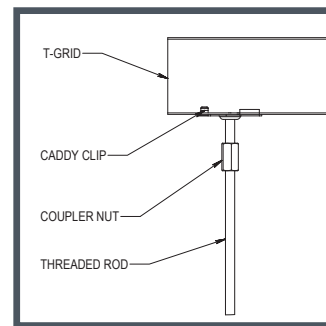
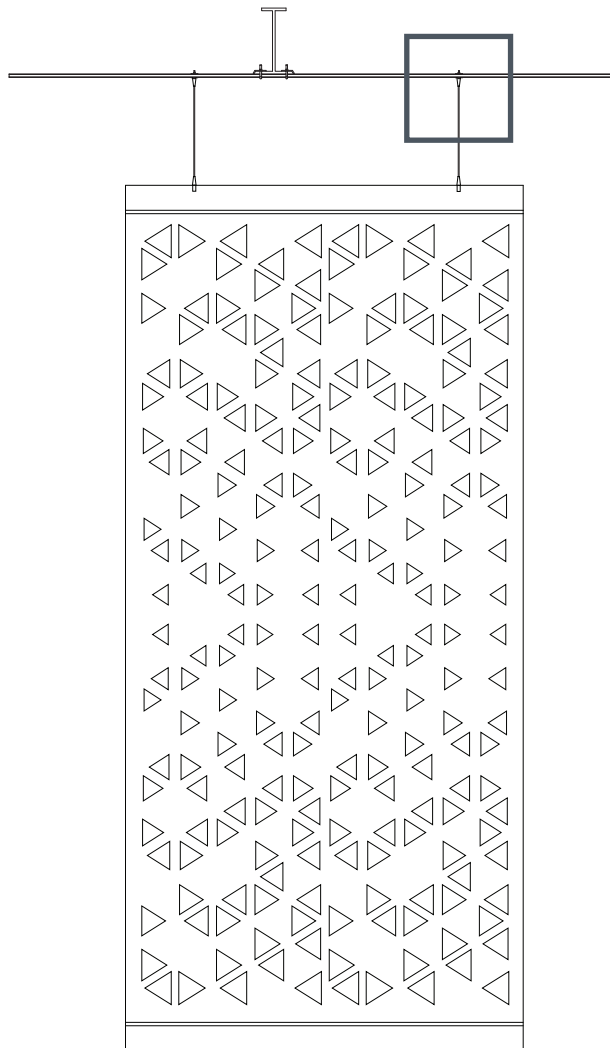

PANL

DIMENSIONS & HARDWARE DETAIL

Track System

